

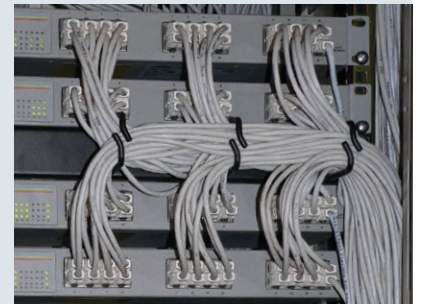

# Surge protection for Ethernet and Fast Ethernet networks

White Paper



## Contents

- Causes of damage
- Structured cabling as uniform connection medium
- EMC concept
- Protective effect of arresters for information technology systems
- Selection of surge protective devices

# Surge protection for Ethernet and Fast Ethernet networks

## White Paper

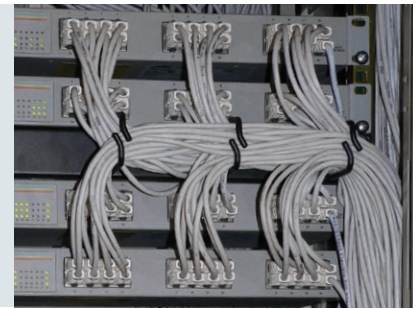

To date, Ethernet is the most commonly used technology for local area networks. The name "Ether" refers to the first radio networks. Introduced in the 1980s, the 10 MBit Ethernet used coaxial cables. Later Fast Ethernet with 100 MBit/s and Gigabit Ethernet with 1000 MBit/s and 10 GBit/s were introduced. All Ethernet versions are based on the same principles. From the 1990s on, Ethernet became the most widely used LAN (Local Area Network) technology and replaced other LAN standards such as Token Ring and ARCNET. Ethernet consists of different types of 50  $\Omega$  coaxial cables or twisted pair cables, glass fibre cables or other media. At present, Ethernet typically has a data rate of 100 MBit/s, however, data rates of 1000 MBit/s are on the rise.

Surges cause malfunction and destruction and thus failure of computer systems. This can significantly affect operations, resulting in long standstill of the installations and systems. Therefore, surge protection concepts are required in addition to the protection of the power supply system and regular data backups to ensure reliable operation of computer systems.

### Causes of damage

Failure of computer systems is typically caused by:

- ➔ Remote lightning strikes causing conducted transients in power supply, data or telecommunication lines,
- ➔ Nearby lightning strikes causing electromagnetic fields that inject transients into power supply, data or telecommunication lines,
- ➔ Direct lightning strikes causing impermissibly high potential differences and partial lightning currents in the building installations.

### Structured cabling as uniform connection medium

Structured cabling is a uniform connection medium for different services such as analogue telephones, ISDN or different network technologies. Consequently, existing installations can be easily adapted to new tasks without exchanging the cables or connection parts. A structured cabling system provides application-independent and universal cables which are not tailored to a specific network topology, manufacturer or product. The type of cables and the topology ensure that all current and future protocols can be used.

A universal cabling system consists of three different hierarchical levels:

1. The **campus backbone cabling** connects the campus distributor of a building complex to the building distributors of the individual buildings. In case of data networks, 50  $\mu\text{m}$ /125  $\mu\text{m}$  multimode optical fibre cables (in case of distances > 2 km monomode optical fibre cables) with a maximum length of about 1500 m are mainly used.

2. The **building backbone cabling** connects the building distributors to the floor distributors. Also in this case, 50  $\mu\text{m}$  optical fibre cables and balanced 100 ohm cables with a length of 500 m are mainly used.
3. The **horizontal cabling** (floor distributor) includes all cables of the work stations of a floor and should not exceed 90 m. Copper cables or in some cases 62.5  $\mu\text{m}$  optical fibre cables are typically used to connect the floor distributor to the telecommunication outlet.

The interfaces between these areas form passive distribution panels. Such distribution panels link the campus backbone, building backbone and horizontal cabling of universal cabling systems. They allow to easily start communication services on a work station by simply patching patch cables. Distribution panels for optical fibre cables (campus backbone and building backbone) and twisted pair cables (horizontal cabling) differ according to the number of ports. For example, 24 ports are commonly used for structured cabling systems and 25 ports for telecommunication installations. Cables are typically installed in 19" data cabinets or racks.

Star topologies are used for generic cabling systems. All currently available protocols can be operated by means of star topologies irrespective of whether they form a logical ring or bus system.

Structured cabling systems connect all terminal devices. They allow communication between telephones, networks, safety systems, building automation systems, LAN and WLAN interconnection as well as access to the intranet and internet. Generic cabling systems ensure flexible use of terminal devices. It is assumed that all information such as data, voice, television, automation and control of machines and installations will be transmitted via Ethernet over the next years and Ethernet will thus become a universal transmission concept. Therefore, electromagnetic compatibility (EMC) must be ensured.

### EMC concept

Electromagnetic compatibility is defined as the capability of a device – especially of an installation or a system – to properly operate in its electromagnetic environment without causing electromagnetic interference itself which would be unacceptable for devices, installations or systems in this environment. To ensure continuous and trouble-free operation of data networks, it is therefore imperative to consider EMC at an early stage. This does not only affect the data cables of the network, but also the entire electrotechnical infrastructure of the buildings and building complexes where the entire network should be installed. Consequently, it is important to consider the electromagnetic environmental conditions:

# Surge protection for Ethernet and Fast Ethernet networks

## White Paper

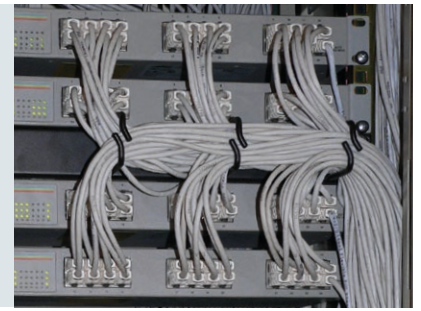

- ➔ Are there potential sources of electromagnetic interference such as radio-relay systems, mobile phone base stations, assembly lines or elevators?
- ➔ What about the quality of the electrical energy (e.g. harmonics, flickers, voltage drops, excess voltages, transients)?
- ➔ What about the risk of a lightning strike (e.g. frequency)?
- ➔ Is there possible emission?

To ensure the performance of data networks even in case of the increased requirements to be expected in the future, special attention has to be given to the electromagnetic compatibility of the installation. Therefore, the design of a data network should include an earthing and equipotential bonding concept which provides information on:

- ➔ Cable duct and cable routing
- ➔ Cable structure
- ➔ Active components
- ➔ Lightning protection
- ➔ Shielding of signal lines
- ➔ Equipotential bonding
- ➔ Surge protection

The most important measures to ensure EMC and thus undisturbed data transmission are:

- ➔ Spatial separation of known sources of electromagnetic interference (e.g. transformer stations, elevator drives) of information technology components
- ➔ Use of closed and earthed metal ducts in case of interference caused by strong radio transmitters and, if required, connection of the terminal devices via optical fibre cables only
- ➔ Use of separate circuits for terminal devices and use of noise filters and uninterrupted power supply systems, if required
- ➔ No parallel installation of power and data lines of terminal devices with power lines of powerful loads (due to the risk of high switching overvoltages when switching on / off the loads) and known sources of interference (e.g. thyristor controllers)
- ➔ Use of shielded data cables which must be earthed on both ends (**Figure 1**). Patch and connecting cables must be integrated in the shielding concept.
- ➔ Integration of the reinforcement (intermeshing) in the equipotential bonding system (**Figure 2**) for metal enclosures and shields (e.g. cable trays, cable ducts)
- ➔ Shielded data cables and power lines should use the same riser duct in the building backbone area. Separate riser

ducts opposed to one another must be avoided. A distance of 20 cm between these two different types of cables should not be exceeded.

- ➔ The power lines for the devices and the relevant data lines must be basically routed via the same cable route. Separating webs should be provided. In the horizontal area, it is advisable to keep a distance of max. 10 cm between these lines.
- ➔ If a lightning protection system is installed on the building, the safety distances between the power/data lines and elements of the external lightning protection system (air-termination systems, down conductors) must be kept and power / data lines must not be routed in parallel with the down conductors of the external lightning protection system.

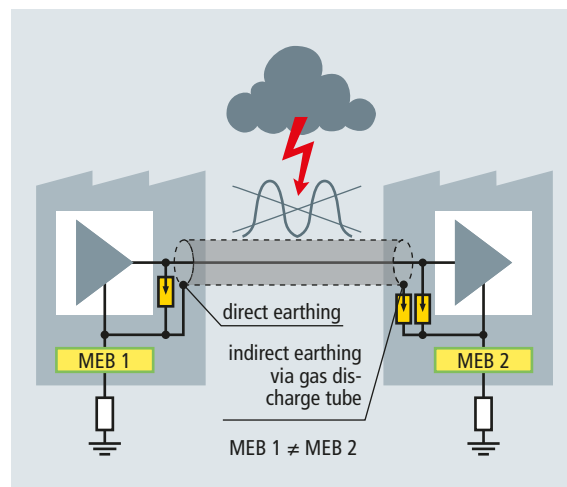

Figure 1 Shield connection on both ends – Shielding from capacitive/inductive coupling and direct and indirect shield earthing to prevent equalising currents

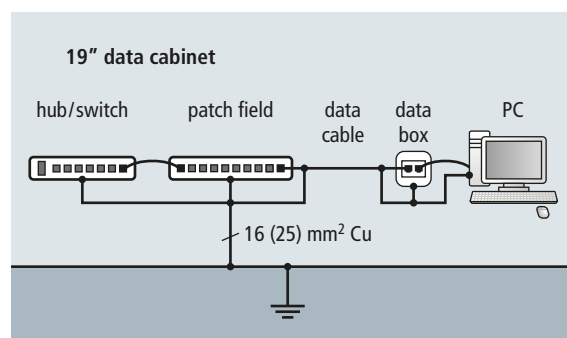
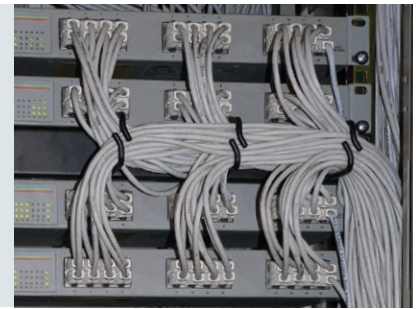

Figure 2 Equipotential bonding of a shielded cable system



# Surge protection for Ethernet and Fast Ethernet networks

## White Paper



- ➔ Use of optical fibre cables for the information technology cables of different buildings (campus backbone cabling)
- ➔ Installation of surge protective devices in power circuits and for the horizontal cabling system to protect them from transients caused by switching operations and lightning discharges (Figures 3 and 4)
- ➔ Power installation in the form of a TN-S system to prevent interference currents on the shields of the data lines
- ➔ Establishing main equipotential bonding with the power installation (PEN) at one point in the building (e.g. service entrance room)

To ensure proper EMC protection, it is also important to choose adequate lightning current and surge arresters for information technology systems and to be familiar with their protective effect.

### Protective effect of arresters for information technology systems

For testing the electromagnetic compatibility (EMC), electrical and electronic equipment (devices) must have a defined immunity to conducted interference (surges).

Different electromagnetic environmental conditions require that the devices have different immunity levels. The immunity level of a device depends on the test level. To define the different immunity levels of terminal devices, the test levels are subdivided into four different levels from 1 to 4. Test level 1 places the lowest requirement on the immunity of a terminal device. The test level can be usually found in the documentation of the device or can be requested from the manufacturer of the device.

Arresters for information technology systems must limit conducted interference to an acceptable level so that the immunity level of the terminal device is not exceeded. For example, an arrester with a lower let-through value than the EMC test values of the terminal device must be selected for a terminal device tested with test level 2: Impulse voltage < 1 kV in combination with an impulse current of some amperes (depending on the type of injection).

Depending on the application and design, the information technology interfaces of terminal devices have different immunity levels. When selecting an adequate surge arrester, not only the system parameters are important, but also the fact whether the arrester is capable of protecting the terminal device. To ensure easy selection, an SPD class sign was developed for the Yellow/Line product family. Together with the documentation of the terminal device, this sign provides exact information on whether an arrester is suitable for the relevant terminal device, namely whether they are energy-coordinated with each other.



Figure 3 NET Protector – Universal surge protective device for protecting the data lines of a floor distributor (also suited for class D networks)



Figure 4 DEHN protector – Universal surge protective device for protecting the network and data lines of a work station

Correctly dimensioned surge arresters reliably protect terminal devices from voltage and energy peaks, thus increasing the availability of the installation.

Modern communication networks are increasingly becoming high-frequency networks and thus more and more susceptible to interference. Therefore, a consistent EMC concept that also includes lightning and surge protection for the buildings and systems is required to ensure smooth network operation (Figure 5).

### Selection of surge protective devices

To ensure effective surge protection, the electricians and IT experts must coordinate the measures for the different systems in cooperation with the manufacturer of the device. Therefore, experts (e.g. engineering consultants) must be called in for large projects.

# Surge protection for Ethernet and Fast Ethernet networks

## White Paper

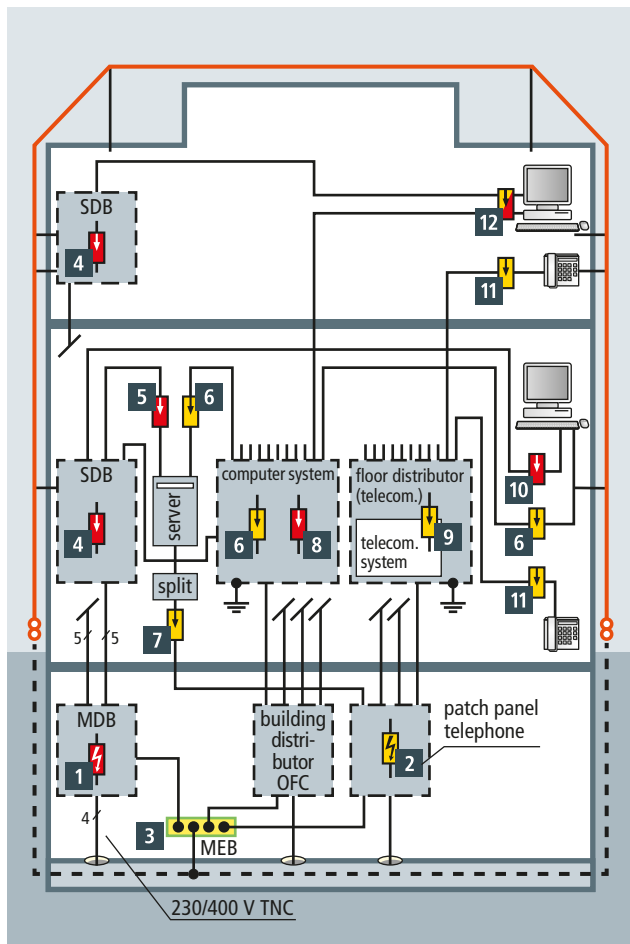
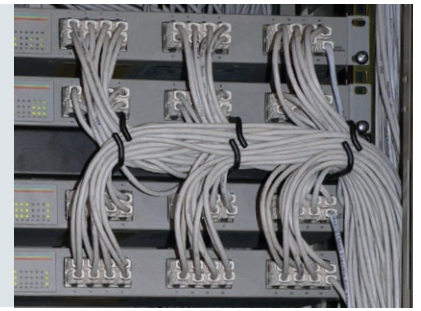

Figure 5 Administration building with highly available installation parts

	SPD	Type	Part No.
1	DEHNventil	DV M TNC 255	951 300
2	Equipotential bonding enclosure	DPG LSA ... P	906 10...
	Disconnection block	TL2 10DA LSA	907 996
	DEHNrapid LSA	DRL 10 B 180 FSD	907 401
	Earthing frame	EF 10 DRL	907 498
	DEHNrapid LSA	DRL PD 180	907 430
3	Equipotential bonding bar	K12	563 200
4	DEHNguard modular	DG M TNS 275	952 400
5	DEHNrail modular	DR M 2P 255	953 200
6	DEHNpatch	DPA M CAT6 RJ45H 48	929 100
7	DEHNlink (upstream of splitter)	DLI TC 2 I	929 028
8	SFL Protector	SFL PRO 6X 19"	909 251
9	NET Protector for 8 x 2 pairs	NET PRO TC 2 LSA	929 072
	19" enclosure	EG NET PRO 19"	929 034
10	DEHNflex M	DFL M 255	924 396
11	DSM telephone protection module	DSM TC 2 SK	924 272
12	DEHNprotector	DPRO 230 LAN100	909 321

## DEHNventil

### DV M TNC 255 (951 300)

- Prewired combined type 1 and type 2 spark-gap-based lightning current and surge arrester consisting of a base part and plug-in protection modules
- Maximum system availability due to RADAX Flow follow current limitation
- Capable of protecting terminal equipment



Figure without obligation

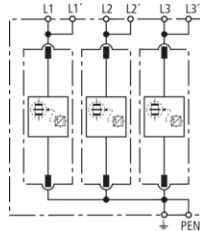

Basic circuit diagram DV M TNC 255

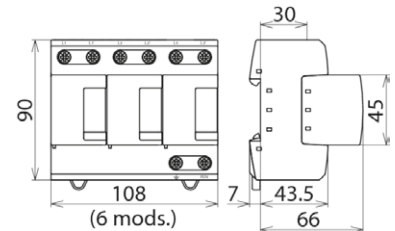

Dimension drawing DV M TNC 255

Modular combined lightning current and surge arrester for protecting TN-C systems against surges.

Type Part No.	DV M TNC 255 951 300
SPD according to EN 61643-11 / IEC 61643-11	type 1 + type 2 / class I + class II
Energy coordination with terminal equipment ( $\leq 5$ m)	type 1 + type 2 + type 3
Nominal a.c. voltage ( $U_N$ )	230 / 400 V (50 / 60 Hz)
Max. continuous operating a.c. voltage ( $U_c$ )	264 V (50 / 60 Hz)
Lightning impulse current (10/350 $\mu$ s) [L1+L2+L3-PEN] ( $I_{total}$ )	75 kA
Specific energy [L1+L2+L3-PEN] (W/R)	1.40 MJ/ohms
Lightning impulse current (10/350 $\mu$ s) [L-PEN] ( $I_{imp}$ )	25 kA
Specific energy [L-PEN] (W/R)	156.25 kJ/ohms
Nominal discharge current (8/20 $\mu$ s) [L-PEN]/[L1+L2+L3-PEN] ( $I_n$ )	25 / 75 kA
Voltage protection level ( $U_p$ )	$\leq 1.5$ kV
Follow current extinguishing capability a.c. ( $I_n$ )	50 kA <sub>rms</sub>
Follow current limitation / Selectivity	no tripping of a 20 A gL/gG fuse up to 50 kA <sub>rms</sub> (prosp.)
Response time ( $t_A$ )	$\leq 100$ ns
Max. backup fuse (L) up to $I_K = 50$ kA <sub>rms</sub>	315 A gG
Max. backup fuse (L-L')	125 A gG
Temporary overvoltage (TOV) ( $U_T$ ) – Characteristic	440 V / 120 min. – withstand
Operating temperature range [parallel] / [series] ( $T_U$ )	-40 °C ... +80 °C / -40 °C ... +60 °C
Operating state / fault indication	green / red
Number of ports	1
Cross-sectional area (L1, L1', L2, L2', L3, L3', PEN, $\pm$ ) (min.)	10 mm <sup>2</sup> solid / flexible
Cross-sectional area (L1, L2, L3, PEN) (max.)	50 mm <sup>2</sup> stranded / 35 mm <sup>2</sup> flexible
Cross-sectional area (L1', L2', L3', $\pm$ ) (max.)	35 mm <sup>2</sup> stranded / 25 mm <sup>2</sup> flexible
For mounting on	35 mm DIN rails acc. to EN 60715
Enclosure material	thermoplastic, red, UL 94 V-0
Place of installation	indoor installation
Degree of protection	IP 20
Capacity	6 module(s), DIN 43880
Approvals	KEMA, VDE, UL, VdS
Extended technical data:	Use in switchgear installations with prospective short-circuit currents of more than 50 kA <sub>rms</sub> (tested by the German VDE)
– Max. prospective short-circuit current	100 kA <sub>rms</sub> (220 kA <sub>peak</sub> )
– Limitation / Extinction of mains follow currents	up to 100 kA <sub>rms</sub> (220 kA <sub>peak</sub> )
– Max. backup fuse (L) up to $I_K = 100$ kA <sub>rms</sub>	315 A gL/gG
Weight	970 g
Customs tariff number	85363030
GTIN	4013364108134
PU	1 pc(s)

## DEHNguard

### DG M TNS 275 (952 400)

- Prewired complete unit consisting of a base part and plug-in protection modules
- High discharge capacity due to heavy-duty zinc oxide varistors / spark gaps
- High reliability due to "Thermo Dynamic Control" SPD monitoring device



Figure without obligation

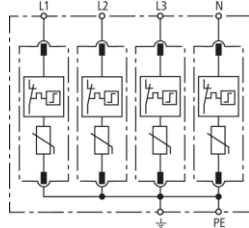

Basic circuit diagram DG M TNS 275

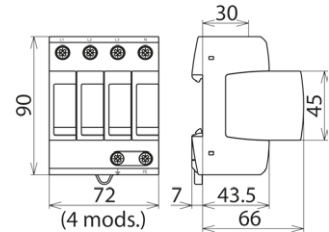

Dimension drawing DG M TNS 275

Modular surge arrester for use in TN-S systems.

Type	DG M TNS 275
Part No.	952 400
SPD according to EN 61643-11 / IEC 61643-11	type 2 / class II
Nominal a.c. voltage ( $U_N$ )	230 / 400 V (50 / 60 Hz)
Max. continuous operating a.c. voltage ( $U_C$ )	275 V (50 / 60 Hz)
Nominal discharge current (8/20 $\mu$ s) ( $I_n$ )	20 kA
Max. discharge current (8/20 $\mu$ s) ( $I_{max}$ )	40 kA
Voltage protection level ( $U_P$ )	$\leq 1.5$ kV
Voltage protection level at 5 kA ( $U_P$ )	$\leq 1$ kV
Response time ( $t_A$ )	$\leq 25$ ns
Max. mains-side overcurrent protection	125 A gG
Short-circuit withstand capability for max. mains-side overcurrent protection ( $I_{SCCR}$ )	50 kA <sub>rms</sub>
Temporary overvoltage (TOV) ( $U_T$ ) – Characteristic	335 V / 5 sec. – withstand
Temporary overvoltage (TOV) ( $U_T$ ) – Characteristic	440 V / 120 min. – safe failure
Operating temperature range ( $T_U$ )	-40 °C ... +80 °C
Operating state / fault indication	green / red
Number of ports	1
Cross-sectional area (min.)	1.5 mm <sup>2</sup> solid / flexible
Cross-sectional area (max.)	35 mm <sup>2</sup> stranded / 25 mm <sup>2</sup> flexible
For mounting on	35 mm DIN rails acc. to EN 60715
Enclosure material	thermoplastic, red, UL 94 V-0
Place of installation	indoor installation
Degree of protection	IP 20
Capacity	4 module(s), DIN 43880
Approvals	KEMA, VDE, UL, VdS
Weight	443 g
Customs tariff number	85363030
GTIN	4013364108455
PU	1 pc(s)

## DEHNrail

### DR M 2P 255 (953 200)

- Two-pole surge arrester consisting of a base element and plug-in protection module
- High discharge capacity due to heavy-duty zinc oxide varistor/spark gap combination
- Energy coordination with other arresters of the Red/Line product family



Figure without obligation

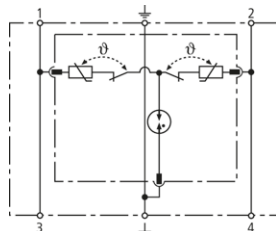

Basic circuit diagram DR M 2P 255

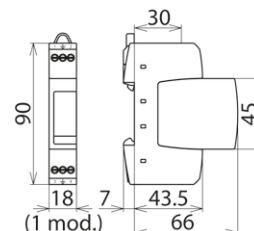

Dimension drawing DR M 2P 255

Two-pole surge arrester consisting of a base part and plug-in protection module

Type	DR M 2P 255
Part No.	953 200
SPD according to EN 61643-11	Type 3
SPD according to IEC 61643-1/-11	Class III
Nominal a.c. voltage ( $U_N$ )	230 V
Max. continuous operating a.c. voltage ( $U_C$ )	255 V
Max. continuous operating d.c. voltage ( $U_C$ )	255 V
Nominal load current a.c. ( $I_L$ )	25 A
Nominal discharge current (8/20 $\mu$ s) ( $I_n$ )	3 kA
Total discharge current (8/20 $\mu$ s) [L+N-PE] ( $I_{total}$ )	5 kA
Combined impulse ( $U_{OC}$ )	6 kV
Combined impulse [L+N-PE] ( $U_{OC total}$ )	10 kV
Voltage protection level [L-N] ( $U_P$ )	$\leq 1250$ V
Voltage protection level [L/N-PE] ( $U_P$ )	$\leq 1500$ V
Response time [L-N] ( $t_A$ )	$\leq 25$ ns
Response time [L/N-PE] ( $t_A$ )	$\leq 100$ ns
Max. mains-side overcurrent protection	25 A gL/gG or B 25 A
Short-circuit withstand capability for mains-side overcurrent protection with 25 A gL/gG	6 kA <sub>rms</sub>
Temporary overvoltage (TOV) [L-N] ( $U_T$ )	335 V / 5 sec.
Temporary overvoltage (TOV) [L/N-PE] ( $U_T$ )	400 V / 5 sec.
Temporary overvoltage (TOV) [L+N-PE] ( $U_T$ )	1200 V + $U_{CS}$ / 200 ms
TOV characteristic [L-N]	withstand
TOV characteristic [L/N-PE]	withstand
TOV characteristic [L+N-PE]	withstand
Operating temperature range ( $T_U$ )	-40°C...+80°C
Operating state/fault indication	green / red
Number of ports	1
Cross-sectional area (min.)	0.5 mm <sup>2</sup> solid/flexible
Cross-sectional area (max.)	4 mm <sup>2</sup> solid/2.5 mm <sup>2</sup> flexible
For mounting on	35 mm DIN rails acc. to EN 60715
Enclosure material	thermoplastic, red, UL 94 V-0
Place of installation	indoor installation
Degree of protection	IP 20
Capacity	1 module(s), DIN 43880
Approvals	KEMA, VDE, UL, VdS, CSA
Weight	81 g
Customs tariff number	85363030
GTIN	4013364108301
PU	1 pc(s)



## DEHNflex

### DFL M 255 (924 396)

- Acoustic fault indication
- Compact design
- For use in flush-mounted systems, cable ducts and flush-type boxes



Figure without obligation

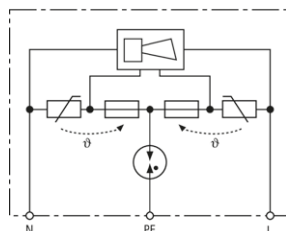

Basic circuit diagram DFL M 255

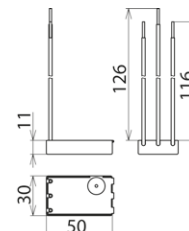

Dimension drawing DFL M 255

Surge arrester for use in all types of installation systems for terminal equipment; compact dimensions

Type Part No.	DFL M 255 924 396
SPD according to EN 61643-11	Type 3
SPD according to IEC 61643-1/-11	Class III
Nominal a.c. voltage ( $U_N$ )	230 V
Max. continuous operating a.c. voltage ( $U_C$ )	255 V
Nominal discharge current (8/20 $\mu$ s) ( $I_n$ )	1.5 kA
Total discharge current (8/20 $\mu$ s) [L+N-PE] ( $I_{total}$ )	3 kA
Combined impulse ( $U_{OC}$ )	3 kV
Combined impulse [L+N-PE] ( $U_{OC, total}$ )	6 kV
Voltage protection level [L-N] ( $U_p$ )	$\leq 1.25$ kV
Voltage protection level [L/N-PE] ( $U_p$ )	$\leq 1.5$ kV
Response time [L-N] ( $t_A$ )	$\leq 25$ ns
Response time [L/N-PE] ( $t_A$ )	$\leq 100$ ns
Max. mains-side overcurrent protection	32 A gL/gG or B/C 32 A
Short-circuit withstand capability for mains-side overcurrent protection with 32 A gL/gG	6 kA <sub>rms</sub>
Temporary overvoltage (TOV) [L-N] ( $U_T$ )	335 V / 5 sec.
Temporary overvoltage (TOV) [L/N-PE] ( $U_T$ )	400 V / 5 sec.
Temporary overvoltage (TOV) [L+N-PE] ( $U_T$ )	1200 V + $U_{CS}$ / 200 ms
TOV characteristic [L-N]	withstand
TOV characteristic [L/N-PE]	withstand
TOV characteristic [L+N-PE]	safe
Fault indication	acoustic signal on
Number of ports	1
Operating temperature range ( $T_U$ )	-25°C...+40°C
Terminal wires	1 mm <sup>2</sup> , 120 mm long
Enclosure material	thermoplastic, red, UL 94 V-2
Place of installation	indoor installation
Degree of protection of installed device	IP 20
Dimensions	30 x 50 x 11 mm
Weight	32 g
Customs tariff number	85363010
GTIN	4013364091016
PU	1 pc(s)

## SFL Protector

### SFL PRO 6X 19" (909 251)

- Surge protection with monitoring device and disconnecter
- Interference suppressor filter
- Visual operating state (green) and fault indication (red)



Figure without obligation

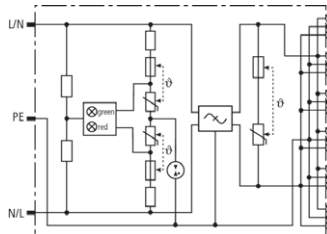

Basic circuit diagram SFL PRO 6X 19"

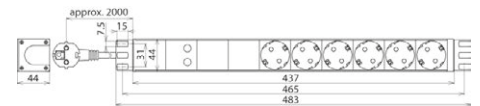

Dimension drawing SFL PRO 6X 19"

Surge protective multiple socket outlet with mains filter for 482.6 mm (19 inches) data cabinets

Type	SFL PRO 6X 19"
Part No.	909 251
SPD according to EN 61643-11	Type 3
SPD according to 61643-1/-11	Class III
Nominal a.c. voltage ( $U_N$ )	230 V
Max. continuous operating a.c. voltage ( $U_C$ )	255 V
Nominal load current a.c. ( $I_L$ )	16 A
Nominal discharge current (8/20 $\mu$ s) ( $I_n$ )	3 kA
Total discharge current (8/20 $\mu$ s) [L+N-PE] ( $I_{total}$ )	5 kA
Combined impulse ( $U_{OC}$ )	6 kV
Combined impulse [L+N-PE] ( $U_{OC total}$ )	10 kV
Voltage protection level ( $U_P$ )	$\leq 1.5$ kV
Response time [L-N] ( $t_A$ )	$\leq 25$ ns
Response time [L/N-PE] ( $t_A$ )	$\leq 100$ ns
Max. mains-side overcurrent protection	16 A gL/gG or B 16 A
Short-circuit withstand capability for mains-side overcurrent protection with 16 A gL/gG	1.5 kA <sub>rms</sub>
Temporary overvoltage (TOV) [L-N] ( $U_T$ )	335 V / 5 sec.
Temporary overvoltage (TOV) [L/N-PE] ( $U_T$ )	400 V / 5 sec.
Temporary overvoltage (TOV) [L+N-PE] ( $U_T$ )	1200 V + $U_{CS}$ / 200 ms
TOV characteristic [L-N]	withstand
TOV characteristic [L/N-PE]	withstand
TOV characteristic [L+N-PE]	safe
Fault indication	red light
Operating state indication	green light
Number of ports	2
Operating temperature range ( $T_U$ )	-20°C...+40°C
Connecting cable	approx. 2000 mm
Number of socket outlets	6
For mounting on	plug-in systems with earth contact according to DIN 49440 / DIN 49441
Enclosure material	anodised aluminium profile, silver
Place of installation	indoor installation
Degree of protection	IP 20
Dimensions	483 x 44 x 44 mm
Mains filter	according to EN 60939-1
Attenuation for f = 1 MHz, balanced	$\geq 32$ dB
Attenuation for f = 1 MHz, unbalanced	$\geq 30$ dB
Weight	1 kg
Customs tariff number	85369010
GTIN	4013364132573
PU	1 pc(s)

## DEHNpatch

### DPA M CAT6 RJ45S 48 (929 100)

- Ideally suited for retrofitting, protection of all lines
- CAT 6A in the channel according to ANSI/TIA/EIA-568
- Power over Ethernet (PoE+ according to IEEE 802.3at)
- For installation in conformity with the lightning protection zone concept at the boundaries from  $0_B -2$  and higher



Figure without obligation

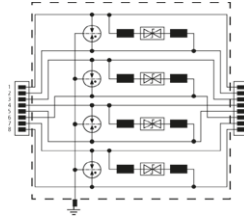

Basic circuit diagram DPA M CAT6 RJ45S 48

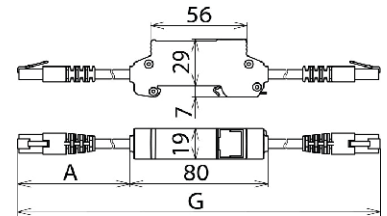

Dimension drawing DPA M CAT6 RJ45S 48

Universal arrester for Industrial Ethernet, Power over Ethernet (PoE+ according to IEEE 802.3at up to 57 V) and similar applications in structured cabling systems according to Cat. 6 and class E<sub>A</sub> up to 500 MHz. Fully shielded type for DIN rail mounting.  
Accessories: Earthing bracket with flat connector sleeve

Type	DPA M CAT6 RJ45S 48
Part No.	929 100
SPD class	<b>TT2-E2P1</b>
Nominal voltage (U <sub>N</sub> )	48 V
Max. continuous operating d.c. voltage (U <sub>c</sub> )	48 V
Max. continuous operating a.c. voltage (U <sub>e</sub> )	34 V
Max. continuous operating d.c. voltage pair-pair (PoE) (U <sub>c</sub> )	57 V
Nominal current (I <sub>N</sub> )	1 A
D1 Lightning impulse current (10/350 μs) per line (I <sub>imp</sub> )	1 kA
C2 Nominal discharge current (8/20 μs) line-line (I <sub>n</sub> )	150 A
C2 Nominal discharge current (8/20 μs) line-PG (I <sub>n</sub> )	2.5 kA
C2 Total nominal discharge current (8/20 μs) line-PG (I <sub>n</sub> )	10 kA
C2 Nominal discharge current (8/20 μs) pair-pair (PoE) (I <sub>n</sub> )	150 A
Voltage protection level line-line for I <sub>n</sub> C2 (U <sub>p</sub> )	≤ 190 V
Voltage protection level line-PG for I <sub>n</sub> C2 (U <sub>p</sub> )	≤ 600 V
Voltage protection level line-line for I <sub>n</sub> C2 (PoE) (U <sub>p</sub> )	≤ 600 V
Voltage protection level line-line at 1 kV/μs C3 (U <sub>p</sub> )	≤ 145 V
Voltage protection level line-PG at 1 kV/μs C3 (U <sub>p</sub> )	≤ 500 V
Voltage protection level pair-pair at 1 kV/μs C3 (PoE) (U <sub>p</sub> )	≤ 600 V
Insertion loss at 250 MHz	≤ 2 dB
Capacitance line-line (C)	≤ 165 pF
Capacitance line-PG (C)	≤ 255 pF
Operating temperature range (T <sub>U</sub> )	-20 °C ... +60 °C
Degree of protection	IP 20
For mounting on	35 mm DIN rails acc. to EN 60715
Connection (input / output)	RJ45 connecting line / RJ45 connecting line
Pinning	1/2, 3/6, 4/5, 7/8
Connecting line	A = approx. 0.5 m, G = approx. 3 m <sup>1)</sup>
Connector	Stewart 39 series
Earthing via	35 mm DIN rail acc. to EN 60715
Enclosure material	zinc die-casting
Colour	bare surface
Test standards	IEC 61643-21 / EN 61643-21
Transmission class according to ISO/IEC 11801	Cat. 6
Transmission class according to EN 50173-1	Class E <sub>A</sub>
Transmission class according to ANSI/TIA/EIA-568	cat. 6A in the channel
Approvals	GHMT, GOST
Accessories	fixing material
Weight	244 g
Customs tariff number	85363010
GTIN	4013364102170
PU	1 pc(s)

<sup>1)</sup> Special lengths on request

## DEHNrapid LSA

### DRL 10 B 180 FSD (907 401)

- Lightning current arrester for use as plug-in SPD block with integrated LSA disconnection block function
- Visual fault indicator of the gas discharge tubes
- Can be combined to a combined lightning current and surge arrester by means of a DRL protective plug
- For installation in conformity with the lightning protection zone concept at the boundaries from  $0_A -1$  and higher

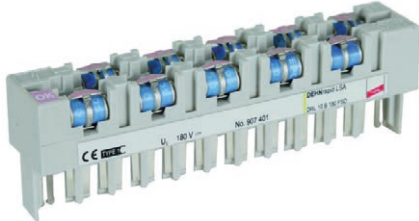
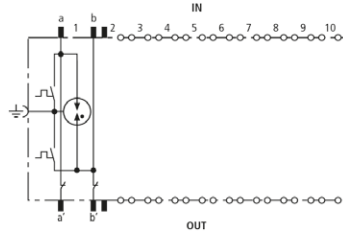
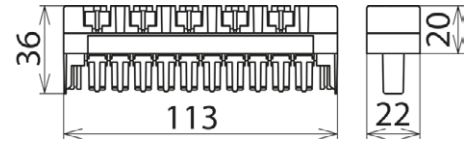

Figure without obligation



Basic circuit diagram DRL 10 B 180 FSD



Dimension drawing DRL 10 B 180 FSD

Lightning current carrying DRL plug-in SPD block (10 pairs) for almost all applications. Expandable to a combined lightning current and surge arrester by means of a DRL protective plug. The integrated disconnection block contacts allow testing, measuring and patching with plugged-in protection. The three-pole gas discharge tubes have a fail-safe function with visual fault indicator.

Type	DRL 10 B 180 FSD
Part No.	907 401
SPD class	TYPE 1 C
Fault indication	visual, colour change
Nominal voltage ( $U_N$ )	180 V
Max. continuous operating d.c. voltage ( $U_C$ )	180 V
Max. continuous operating a.c. voltage ( $U_C$ )	127 V
Nominal current ( $I_N$ )	0.4 A
D1 Total lightning impulse current (10/350 $\mu$ s) ( $I_{imp}$ )	5 kA
D1 Lightning impulse current (10/350 $\mu$ s) per line ( $I_{imp}$ )	2.5 kA
C2 Total nominal discharge current (8/20 $\mu$ s) ( $I_n$ )	10 kA
C2 Nominal discharge current (8/20 $\mu$ s) per line ( $I_n$ )	5 kA
Voltage protection level line-line for $I_{imp}$ D1 ( $U_p$ )	$\leq 500$ V
Voltage protection level line-PG for $I_{imp}$ D1 ( $U_p$ )	$\leq 500$ V
Voltage protection level line-line at 1 kV/ $\mu$ s C3 ( $U_p$ )	$\leq 500$ V
Voltage protection level line-PG at 1 kV/ $\mu$ s C3 ( $U_p$ )	$\leq 450$ V
Series resistance per line	$\leq 0.005$ ohms
Capacitance line-line (C)	$\leq 5$ pF
Capacitance line-PG (C)	$\leq 5$ pF
Fail-safe function	gas discharge tube with spring contacts
Operating temperature range ( $T_U$ )	-40 °C ... +80 °C
Degree of protection	IP 10
Plugs into	LSA disconnection block 2/10
Earthing via	mounting frame
Enclosure material	polyamide PA 6.6
Colour	grey
Test standards	IEC 61643-21 / EN 61643-21
Approvals	VdS, GOST
Weight	69 g
Customs tariff number	85363010
GTIN	4013364107564
PU	10 pc(s)

## DEHNrapid LSA

### DRL PD 180 (907 430)

- For maximum transmission rates - combined with overcurrent protection
- Energy-coordinated with DRL plug-in SPD block
- For installation in conformity with the lightning protection zone concept at the boundaries from 1 – 2 and higher



Figure without obligation

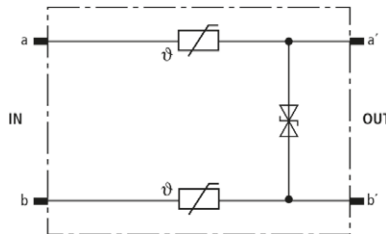

Basic circuit diagram DRL PD 180

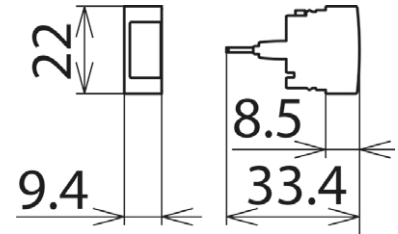

Dimension drawing DRL PD 180

Protective plug (one pair), energy-coordinated with DRL plug-in SPD block, for use as single-stage protective device for terminal equipment. Low voltage protection level line-line and integrated overcurrent protection for ADSL, ISDN  $U_{ko}$  or a/b lines. To be mounted into EF 10 DRL. Installation recommended only in combination with DRL plug-in SPD block.

Type Part No.	DRL PD 180 907 430
SPD class	<b>TYPE 2 P1</b>
Nominal voltage ( $U_N$ )	180 V
Max. continuous operating d.c. voltage ( $U_c$ )	180 V
Max. continuous operating a.c. voltage ( $U_c$ )	127 V
Nominal current ( $I_n$ )	0.1 A
D1 Total lightning impulse current (10/350 $\mu$ s) in combination with DRL 10 B... ( $I_{imp}$ )	5 kA
D1 Lightning impulse current (10/350 $\mu$ s) per line in combination with DRL 10 B... ( $I_{imp}$ )	2.5 kA
C2 Total nominal discharge current (8/20 $\mu$ s) in combination with DRL 10 B... ( $I_n$ )	10 kA
C2 Nominal discharge current (8/20 $\mu$ s) per line in combination with DRL 10 B... ( $I_n$ )	5 kA
C1 Nominal discharge current (8/20 $\mu$ s) per line without DRL 10 B... ( $I_n$ )	0.25 kA
Voltage protection level line-PG for $I_{imp}$ D1 in combination with DRL 10 B... ( $U_p$ )	$\leq 500$ V
Voltage protection level line-line at 1 kV/ $\mu$ s C3 ( $U_p$ )	$\leq 270$ V
Series resistance per line	10 ohms +/- 15%
Cut-off frequency line-line ( $f_c$ )	61 MHz
Capacitance line-line (C)	$\leq 80$ pF
Version	integrated overcurrent protection
Operating temperature range ( $T_U$ )	0 °C ... +70 °C
Degree of protection	IP 20 (when plugged in)
Plugs into	LSA disconnection block 2/10 or DRL 10 B... plug-in SPD block
Enclosure material	polyamide PA 6.6
Colour	yellow
Test standards	IEC 61643-21 / EN 61643-21
Approvals	GOST, VdS
Weight	4 g
Customs tariff number	85363010
GTIN	4013364107670
PU	10 pc(s)



## DEHNrapid LSA

### EF 10 DRL (907 498)

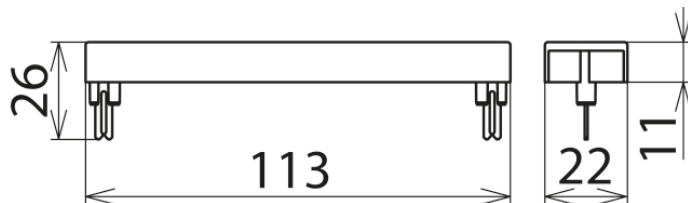

Figure without obligation

Dimension drawing EF 10 DRL

Snap-on earthing frame for earthing and mounting max. 10 DRL protective plugs. Plugs into a 10-pair disconnection block or DRL plug-in SPD block.

Type	EF 10 DRL
Part No.	907 498
Plugs into	LSA disconnection blocks or DRL SPD plug-in block
Earthing via	mounting frame or DRL SPD plug-in block
Enclosure material	polyamide PA 6.6
Colour	yellow
Weight	10 g
Customs tariff number	85389099
GTIN	4013364107540
PU	1 pc(s)

### TL2 10DA LSA (907 996)

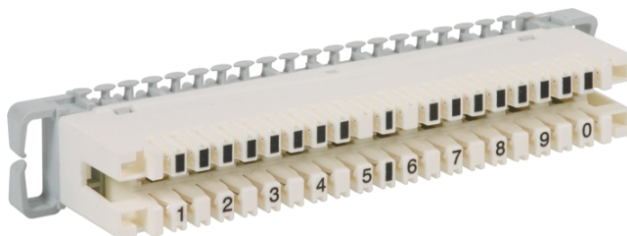

Figure without obligation

Type 2 for LSA technology for connecting 10 pairs each on the cable and routing side. Protection is provided between the disconnection contacts as soon as DRL components are plugged in. DPL 10 G3 arresters can also be plugged into the disconnection block.

Type	TL2 10DA LSA
Part No.	907 996
Enclosure material	PBT
Test standards	DIN 47608-1, -2
Approvals	compliance with DTAG TS 0272/96
Diameter of solid conductors	0.40-0.80 mm
Conductor diameter with insulation	0.70-1.50 mm
Contacting frequency for conductor diameters $\leq 0.65$ mm	$> 50$ x
Contacting frequency for conductor diameters of 0.8 mm	$\leq 50$ x
Contact material	special brass
Contact surface	silver
Flame protection	UL 94 V-0
Insulation resistance	5x 10.000 Mohms
Volume resistance of IPC terminal	$< 10$ mohms
Electric strength	2 kV / 50 Hz
Weight	60 g
Customs tariff number	85369010
GTIN	4013364033535
PU	1 pc(s)

## DSM

### DSM TC 2 SK (924 272)

- Excellent transmission performance
- Also suitable for installation into distribution boards
- For installation in conformity with the lightning protection zone concept at the boundaries from  $0_B - 2$  and higher



Figure without obligation

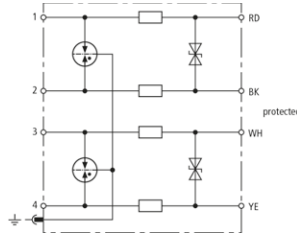

Basic circuit diagram DSM TC 2 SK

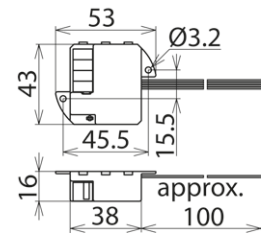

Dimension drawing DSM TC 2 SK

Energy-coordinated two-stage surge arrester free of leakage currents to earth for (system) telephones,  $U_{k0}$ -ADSL, for two pairs.

Type	DSM TC 2 SK
Part No.	924 272
SPD class	TYPE 2/P2
Nominal voltage ( $U_N$ )	130 V
Max. continuous operating d.c. voltage ( $U_c$ )	170 V
Nominal current ( $I_n$ )	200 mA
D1 Lightning impulse current (10/350 $\mu$ s) per line ( $I_{imp}$ )	1 kA
C2 Total nominal discharge current (8/20 $\mu$ s) ( $I_n$ )	20 kA
C2 Nominal discharge current (8/20 $\mu$ s) per line ( $I_n$ )	5 kA
Voltage protection level line-line for $I_n$ C2 ( $U_p$ )	$\leq 275$ V
Voltage protection level line-PG for $I_n$ C2 ( $U_p$ )	$\leq 600$ V
Voltage protection level line-line at 1 kV/ $\mu$ s C3 ( $U_p$ )	$\leq 220$ V
Voltage protection level line-PG at 1 kV/ $\mu$ s C3 ( $U_p$ )	$\leq 600$ V
Series resistance per line	4.7 ohms
Cut-off frequency ( $f_c$ )	17 MHz
Capacitance line-line (C)	$\leq 300$ pF
Capacitance line-PG (C)	$\leq 10$ pF
Operating temperature range ( $T_U$ )	-40 °C ... +80 °C
Degree of protection	IP 20
Connection (input / output)	four-pole terminal / stranded conductors (0.25 mm <sup>2</sup> )
Pinning	2 pairs
Connection diameter, solid	0.5-1.0 mm
Earthing via	flat connector (2.8 mm)
Enclosure material	polyamide PA 6.6
Colour	yellow
Test standards	IEC 61643-21 / EN 61643-21
Approvals	GOST
Accessories	flat connector, 500 mm earthing conductor
Weight	45 g
Customs tariff number	85363010
GTIN	4013364082984
PU	1 pc(s)

## DEHNlink

### DLI TC 2 I (929 028)

- LED display for supply voltage
- Integrated protection against power crossing
- For installation in conformity with the lightning protection zone concept at the boundaries from  $0_B -2$  and higher



Figure without obligation

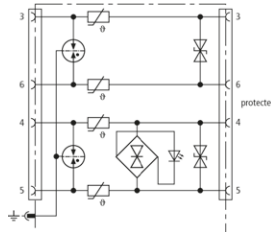

Basic circuit diagram DLI TC 2 I

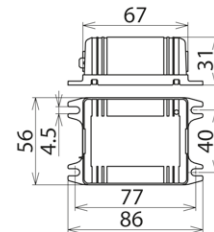

Dimension drawing DLI TC 2 I

Two-stage surge arrester with overcurrent protection for analogue or system telephones with operating state indication (LED). Even protects from alternating current interference. Pins compatible with RJ11/12 plugs. Connecting cable and mounting material included.

Type Part No.	DLI TC 2 I 929 028
SPD class	TYPE 2P2
Nominal voltage ( $U_N$ )	130 V
Max. continuous operating d.c. voltage ( $U_c$ )	170 V
Max. continuous operating a.c. voltage ( $U_c$ )	120 V
Nominal current ( $I_L$ )	150 mA
D1 Lightning impulse current (10/350 $\mu$ s) per line ( $I_{imp}$ )	1 kA
C2 Total nominal discharge current (8/20 $\mu$ s) ( $I_n$ )	10 kA
C2 Nominal discharge current (8/20 $\mu$ s) per line ( $I_n$ )	2.5 kA
Voltage protection level line-line for $I_n$ C2 ( $U_p$ )	$\leq 250$ V
Voltage protection level line-PG for $I_n$ C2 ( $U_p$ )	$\leq 600$ V
Voltage protection level line-line at 1 kV/ $\mu$ s C3 ( $U_p$ )	$\leq 230$ V
Voltage protection level line-PG at 1 kV/ $\mu$ s C3 ( $U_p$ )	$\leq 600$ V
Series resistance per line	10 ohms
Cut-off frequency line-line	10 MHz
Capacitance line-line (C)	$\leq 0.3$ nF
Capacitance line-PG (C)	$\leq 15$ pF
Operating temperature range ( $T_U$ )	-40 °C ... +80 °C
Degree of protection	IP 20
Connection (input / output)	RJ45 / RJ 45 (compatible with RJ12)
Pinning	3/6, 4/5 (3/4, 2/5 for RJ12)
Earthing via	flat connector (6.3 mm)
Enclosure material	polyamide PA 6.6
Colour	yellow
Test standards	IEC 61643-21 / EN 61643-21
Approvals	GOST
Accessories	connecting cable, mounting material
Weight	101 g
Customs tariff number	85363010
GTIN	4013364093379
PU	1 pc(s)

## NET Protector

### NET PRO TC 2 LSA (929 072)

- Patch panel or retrofit version
- Integrated protection against power crossing
- For installation in conformity with the lightning protection zone concept at the boundaries from  $0_B -2$  and higher

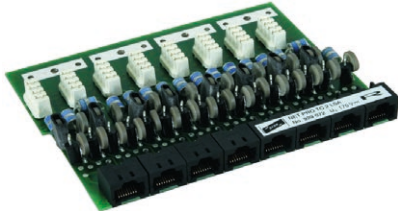
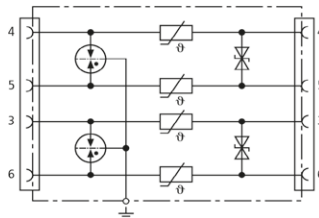
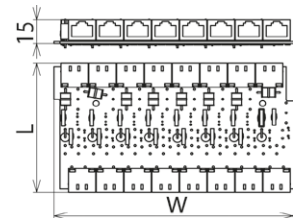

Figure without obligation



Basic circuit diagram NET PRO TC 2 LSA



Dimension drawing NET PRO TC 2 LSA

Surge protection component with eight unshielded ports for protecting telecommunications systems with analogue or system transmission from overvoltage and a.c. interference. PTC thermistors decouple the protection stages and thus additionally protect terminal equipment in case of power crossing. To be mounted into EG NET PRO 19" as patch panel or patch panel version (LSA).

Type Part No.	NET PRO TC 2 LSA 929 072
SPD class	TYPE2P2
Nominal voltage ( $U_N$ )	130 V
Max. continuous operating d.c. voltage ( $U_c$ )	170 V
Max. continuous operating a.c. voltage ( $U_c$ )	120 V
Nominal current ( $I_L$ )	150 mA
D1 Lightning impulse current (10/350 $\mu$ s) per line ( $I_{imp}$ )	1 kA
C2 Nominal discharge current (8/20 $\mu$ s) per port ( $I_n$ )	20 kA
C2 Nominal discharge current (8/20 $\mu$ s) per line ( $I_n$ )	5 kA
Voltage protection level line-line for $I_n$ C2 ( $U_p$ )	$\leq 275$ V
Voltage protection level line-PG for $I_n$ C2 ( $U_p$ )	$\leq 600$ V
Voltage protection level line-line at 1 kV/ $\mu$ s C3 ( $U_p$ )	$\leq 230$ V
Voltage protection level line-PG at 1 kV/ $\mu$ s C3 ( $U_p$ )	$\leq 600$ V
Series resistance per line	10 ohms
Cut-off frequency line-line ( $f_c$ )	10 MHz
Capacitance line-line (C)	$\leq 300$ pF
Capacitance line-PG (C)	$\leq 25$ pF
Operating temperature range ( $T_U$ )	-40 °C ... +80 °C
Degree of protection	IP 00
For mounting on	enclosure
Connection (input / output)	LSA / RJ45
Pinning	4/5, 3/6
Earthing via	enclosure
Dimensions (W x L)	135 x 107 mm
Test standards	IEC 61643-21 / EN 61643-21
Approvals	GOST
Weight	257 g
Customs tariff number	85363010
GTIN	4013364083165
PU	1 pc(s)

### 482.6 mm (19 inch) Enclosure

Fully shielded empty enclosure for max. three NET Protector protection components.



Type Part No.	EG NET PRO 19" 929 034
Dimensions	1 vertical module
Enclosure material	stainless steel front / galvanised sheet metal
Weight	2,36 kg
Customs tariff number	85389099
GTIN	4013364072145
PU	1 pc(s)

## DEHNprotector

### DPRO 230 LAN100 (909 321)

Figure without obligation



- Surge protective device for Ethernet components (1000 BASE-T) with an elegant design
- Shielded Cat 5e patch cable (1.5 m) included
- For installation in conformity with the lightning protection zone concept at the boundaries from 2 – 3 and higher

Combined surge protection for the power side and data input for protecting LAN components. Protection of all pairs for Ethernet pin assignment. It meets the requirements for channel class D in accordance with EN 50173 and is thus suitable for 1000 Base-T (Gigabit Ethernet). With visual operating state and fault indication and integrated child lock.

#### Protection of the data side

Type Part No.	DPRO 230 LAN100 909 321
SPD class	TYPE 2 P1
Max. continuous operating d.c. voltage ( $U_c$ )	58 V
Lightning impulse current (10/350 $\mu$ s) per line D1 ( $I_{imp}$ )	1 kA
C2 Nominal discharge current (8/20 $\mu$ s) line-line ( $I_n$ )	30 A
C2 Nominal discharge current (8/20 $\mu$ s) line-PE ( $I_n$ )	2.5 kA
C2 Total nominal discharge current (8/20 $\mu$ s) ( $I_n$ )	10 kA
Voltage protection level line-line for $I_n$ C2 ( $U_p$ )	$\leq 100$ V
Voltage protection level line-PE for $I_n$ C2 ( $U_p$ )	$\leq 500$ V
Voltage protection level line-line at 1 kV/ $\mu$ s C3 ( $U_p$ )	90 V
Voltage protection level line-PE at 1 kV/ $\mu$ s C3 ( $U_p$ )	$\leq 500$ V
Cut-off frequency ( $f_c$ )	120 MHz
Operating temperature range ( $T_u$ )	-25 °C ... +40 °C
Degree of protection	IP 20
Connection (input / output)	shielded RJ45 socket / shielded RJ45 socket
Pinning	1/2, 3/6, 4/5, 7/8
Earthing via	protective conductor connection
Enclosure material	thermoplastic, UL 94 V-2
Colour	pure white
Test standards	IEC 61643-21 / EN 61643-21

#### Protection of the power side

Type Part No.	DPRO 230 LAN100 909 321
SPD according to EN 61643-11 / IEC 61643-11	type 3 / class III
Nominal a.c. voltage ( $U_n$ )	230 V (50 / 60 Hz)
Max. continuous operating a.c. voltage ( $U_c$ )	255 V (50 / 60 Hz)
Nominal load current a.c. ( $I_L$ )	16 A
Nominal discharge current (8/20 $\mu$ s) ( $I_n$ )	3 kA
Total discharge current (8/20 $\mu$ s) [L+N-PE] ( $I_{total}$ )	5 kA
Combination wave ( $U_{oc}$ )	6 kV
Combination wave [L+N-PE] ( $U_{oc total}$ )	10 kV
Voltage protection level [L-N] ( $U_p$ )	$\leq 1.25$ kV
Voltage protection level [L/N-PE] ( $U_p$ )	$\leq 1.5$ kV
Response time [L-N] ( $t_A$ )	$\leq 25$ ns
Response time [L/N-PE] ( $t_A$ )	$\leq 100$ ns
Max. mains-side overcurrent protection	B 16 A
Short-circuit withstand capability for mains-side overcurrent protection ( $I_{SCCR}$ )	1 kA <sub>rms</sub>
Temporary overvoltage (TOV) [L-N] ( $U_T$ ) – Characteristic	335 V / 5 sec. – withstand
Temporary overvoltage (TOV) [L-N] ( $U_T$ ) – Characteristic	440 V / 120 min. – safe failure
Temporary overvoltage (TOV) [L/N-PE] ( $U_T$ ) – Characteristic	335 V / 120 min. – withstand
Temporary overvoltage (TOV) [L/N-PE] ( $U_T$ ) – Characteristic	440 V / 5 sec. – withstand
Temporary overvoltage (TOV) [L+N-PE] ( $U_T$ ) – Characteristic	1200 V + $U_{REF}$ / 200 ms – safe failure
Fault indication	red indicator light
Operating state indication	green indicator light
Number of ports	1
For mounting on	earthed socket outlets according to DIN 49440/DIN 49441
Test standards	EN 61643-11
Weight	222 g
Customs tariff number	85363010
GTIN	4013364126152
PU	1 pc(s)



Equipotential busbar

 **PAS 11AK (563 200)**



Figure without obligation

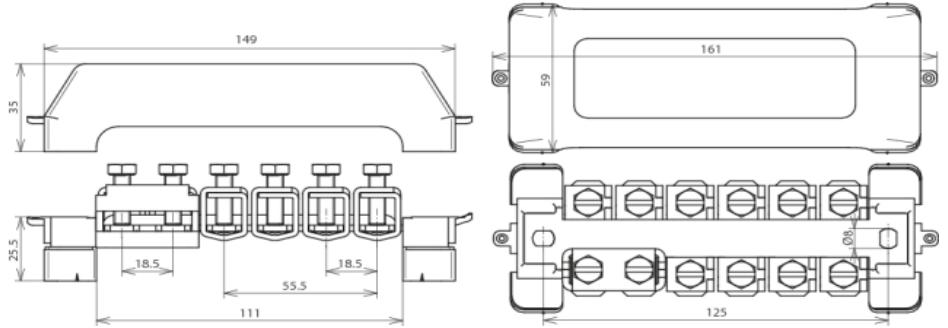

Part No.	563 200
Connection (solid / stranded)	10 x 2.5-95 mm <sup>2</sup>
Connection Rd	or 10 x -10 mm
Connection FI	1 x -30 x 4 mm
Contact bar	Cu/gal Sn
Cross section	30 mm <sup>2</sup>
Fixing	[2x] 6 x 8 mm
Fixing frames	P (grey)
Cover	P (grey/sealable)
Standard	EN 62561-1
Type	halogen-free
Weight	410 g
Customs tariff number	85389099
GTIN	4013364056558
PU	1 pc(s)

## Enclosure for equipotential bonding

### DPG LSA 30 P (906 100)

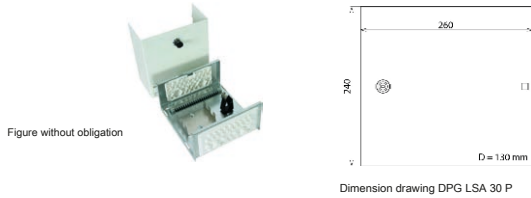

### DPG LSA 60 P (906 101)

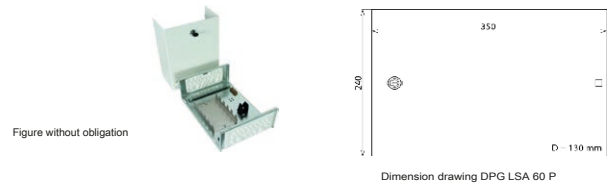

DPG LSA is a completely premounted enclosure system with LSA mounting frame and allows optimised use of arresters and shield connection systems (constant force spring).

- Lightning current carrying earthing system for arresters and shield connection
- Integrated mounting frame for LSA blocks with a grid dimension of 30 mm
- Extra space for uninterfered cable routing and surge arresters

Type Part No.	DPG LSA 30 P 906 100
Carrying capacity of connection elements D1 Total lightning impulse current (10/350 µs) ( $I_{imp}$ )	15 kA
LSA mounting frame for	1x 3 blocks 2/10
Grid dimension of mounting frame	30 mm
Wire guides	1 pc(s).
Cable entries	top / bottom
Cable rail	top / bottom
Lock	yes
For mounting on	walls
Degree of protection	IP 40
Earthing via	earthing block
Dimensions W x H x D	240 x 260 x 130 mm
Enclosure material	sheet steel
Colour	RAL 9002
Weight	3,4 kg
Customs tariff number	85381000
GTIN	4013364106598
PU	1 pc(s)

Type Part No.	DPG LSA 60 P 906 101
Carrying capacity of connection elements D1 Total lightning impulse current (10/350 µs) ( $I_{imp}$ )	30 kA
LSA mounting frame for	1x 6 blocks 2/10
Grid dimension of mounting frame	30 mm
Wire guides	2 pc(s).
Cable entries	top / bottom
Cable rail	top / bottom
Lock	yes
For mounting on	walls
Degree of protection	IP 40
Earthing via	earthing block
Dimensions W x H x D	240 x 350 x 130 mm
Enclosure material	sheet steel
Colour	RAL 9002
Weight	4,97 kg
Customs tariff number	85381000
GTIN	4013364106604
PU	1 pc(s)

## Enclosure for equipotential bonding

### DPG LSA 120 P (906 102)

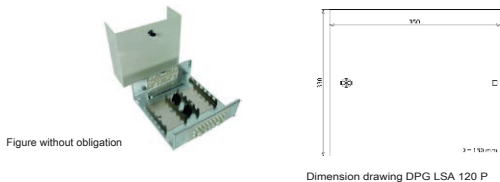

### DPG LSA 220 P (906 103)

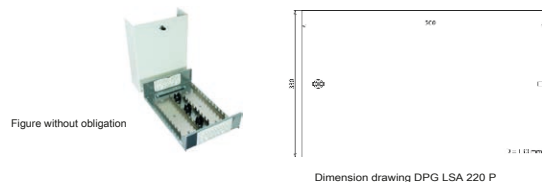

DPG LSA is a completely premounted enclosure system with LSA mounting frame and allows optimised use of arresters and shield connection systems (constant force spring).

- Lightning current carrying earthing system for arresters and shield connection
- Integrated mounting frame for LSA blocks with a grid dimension of 30 mm
- Extra space for uninterfered cable routing and surge arresters

Type Part No.	DPG LSA 120 P 906 102
Carrying capacity of connection elements D1 Total lightning impulse current (10/350 µs) ( $I_{imp}$ )	50 kA
LSA mounting frame for	2x 6 blocks 2/10
Grid dimension of mounting frame	30 mm
Wire guides	2 pc(s).
Cable entries	top / bottom
Cable rail	top / bottom
Lock	yes
For mounting on	walls
Degree of protection	IP 40
Earthing via	earthing block
Dimensions W x H x D	330 x 350 x 130 mm
Enclosure material	sheet steel
Colour	RAL 9002
Weight	5,7 kg
Customs tariff number	85381000
GTIN	4013364106611
PU	1 pc(s)

Type Part No.	DPG LSA 220 P 906 103
Carrying capacity of connection elements D1 Total lightning impulse current (10/350 µs) ( $I_{imp}$ )	50 kA
LSA mounting frame for	2x 11 blocks 2/10
Grid dimension of mounting frame	30 mm
Wire guides	3 pc(s).
Cable entries	top / bottom
Cable rail	top / bottom
Lock	yes
For mounting on	walls
Degree of protection	IP 40
Earthing via	earthing block
Dimensions W x H x D	330 x 500 x 130 mm
Enclosure material	sheet steel
Colour	RAL 9002
Weight	7,65 kg
Customs tariff number	85381000
GTIN	4013364106628
PU	1 pc(s)

[www.dehn-international.com/partners](http://www.dehn-international.com/partners)



**Surge Protection  
Lightning Protection  
Safety Equipment  
DEHN protects.**

DEHN + SÖHNE  
GmbH + Co.KG.

Hans-Dehn-Str. 1  
Postfach 1640  
92306 Neumarkt  
Germany

Tel. +49 9181 906-0  
Fax +49 9181 906-1100  
info@dehn.de  
[www.dehn-international.com](http://www.dehn-international.com)



[www.dehn-international.com/partners](http://www.dehn-international.com/partners)

Type designations of products mentioned in the white paper being at the same time registered trademarks are not especially marked. So if there is no marking of <sup>TM</sup> or © this does not mean that the type designation is a free trade name. Neither it can be seen whether patents or utility models and other intellectual and industrial property rights are available. We reserve the right to introduce changes in performance, configuration and technology, dimensions, weights and materials in the course of technical progress. The figures are shown without obligation. Misprints, errors and modifications excepted. Reproduction in any form whatsoever is forbidden without our authorisation.

actiVsense, BLITZDUCTOR, BLITZPLANER, DEHN, DEHN Logo, DEHN schützt, DEHnbloc, DEHNfix, DEHNgrip, DEHNguard, DEHNport, DEHNQUICK, DEHNrapid, DEHNshield, DEHNSnap, DEHNventil, HVI, LifeCheck, Red/Line are protected by German Trade Mark, by Community Trade Mark (EU) and/or in other countries.

Photo "Switches in rack" by Parkis ([http://commons.wikimedia.org/wiki/File:Switches\\_in\\_rack.jpg](http://commons.wikimedia.org/wiki/File:Switches_in_rack.jpg)); Licence: CC BY-SA 2.5 (<http://creativecommons.org/licenses/by-sa/2.5/>)